

Article number: 12708000030120

Description: KLEE-coil 708 000 030.120
M3 Unhardened, zinc-pl. & chr. yellow

Measures

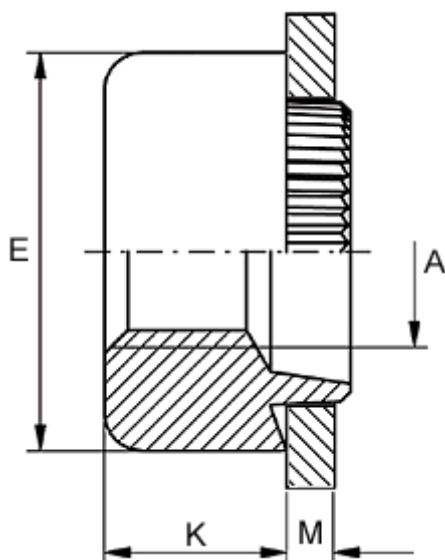

Female thread A	= M3
Height K	= 3.0
Outer diameter E	= 8.0
Plate thickness	= 2.0 to 2.2
Recommended bore diameter for extreme load	= 6.0
Recommended bore diameter for normal use	= 6.0